

# SW102 DISPLAY

User Guide



# TABLE OF CONTENTS

<b>SW102 Display User Guide.....</b>	<b>2</b>
Product Details.....	2
Dimensions & Materials.....	2
Quick Start Guide .....	3
Functionalities.....	4
Installation .....	9
Pin Layout.....	9
Certification.....	9



# SW102 Display User Guide

## Product Details

### Product Name

Intelligent OLED display, model: SW102

Firmware: CYCMOTOR LTD specific firmware

### Features

- Minimalist design and process
- High brightness, high contrast 1.3-inch monochromatic OLED screen
- Excellent outdoor design with IP65 waterproof rating

## Dimensions & Materials

### Materials

Product shell – ABS + PC plastic

Transparent window – 2.5D Tempered glass

### Dimensions

L 23mm x W 40mm x H 63mm

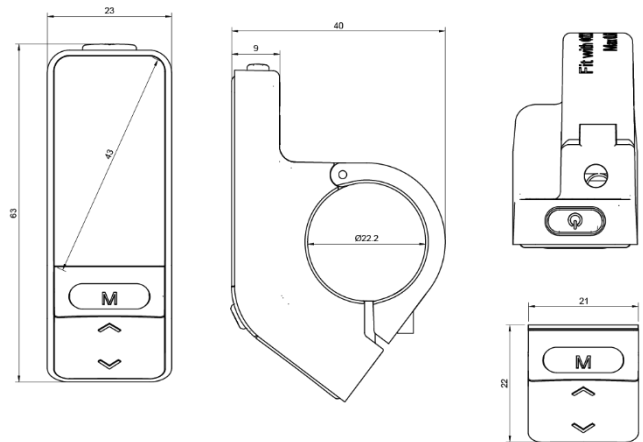

## Electrical Specifications

- Power supply: DC 36V / 48V / 52V
- Rated current: 12mA
- Shutdown leakage current: <math><1\mu\text{A}</math>
- Screen specification: 1/3" OLED (64\*128 dots)
- Communication method: UART (default)
- Operating temperature: -20°C ~ 80°C
- Storage temperature: -30°C ~ 80°C
- Waterproof level: IP65

## Quick Start Guide

After unboxing and installing your CYC motor system, there are two main things you need to set up.

1. Change your Battery No. setting according to your rated voltage.
  - a. Within 15 seconds of turning on your display, long press the MENU button to enter



the settings functions. Press UP/DOWN to navigate the settings page & MENU to select.

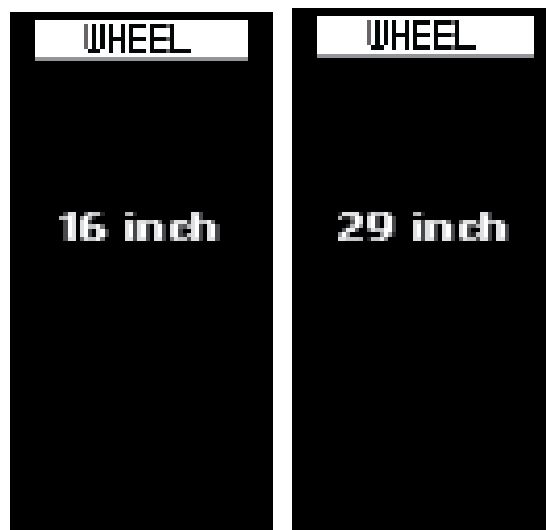

2. Change your Wheel setting according to your bike's wheel size.
3. Now you can set things up like your temperature and speed unit as well as your brightness level.



## Functionalities

### Power On/Off

Press and hold the POWER button for 2 seconds to turn the display on/off. The display will automatically shut down when there is no operation for a period of time.

### Navigation

1. POWER
2. MENU
3. UP
4. DOWN

The MENU button is used to go into your settings page & clear data page. It is also used to enter and select a setting or function & finally, it's also used to switch between the various main dashboard information.

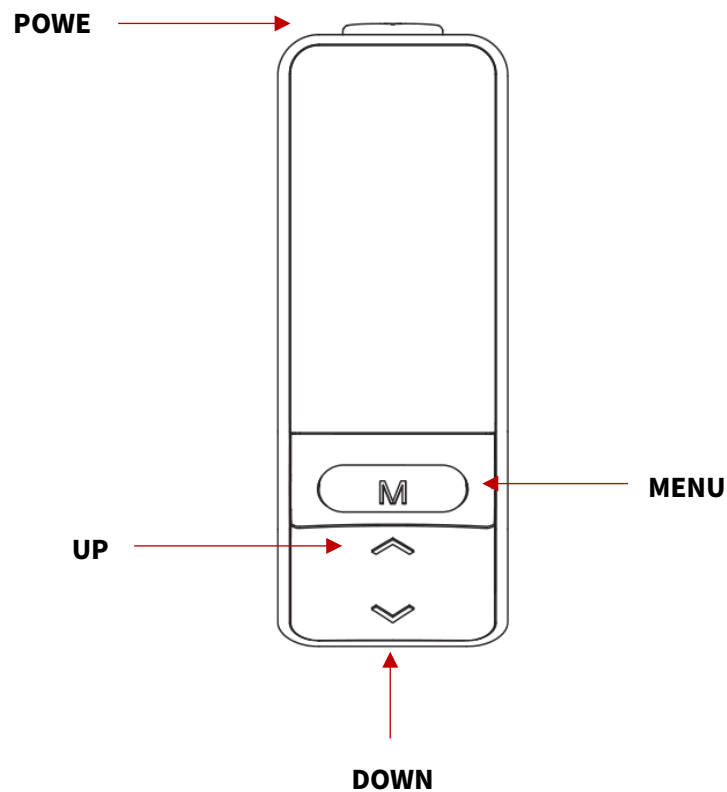

## Switch Dashboard

Switch the main dashboard to display different information by pressing the MENU button.

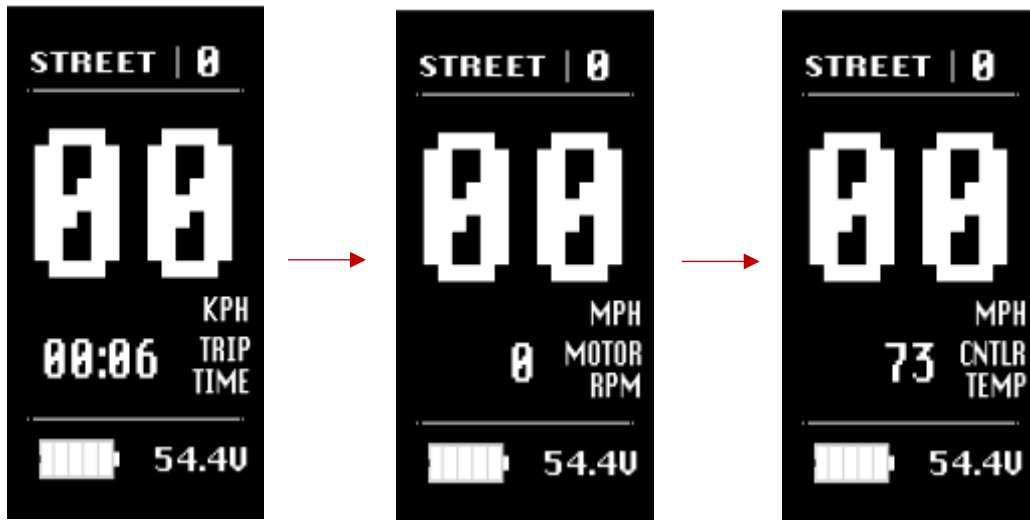

## Assist Level Operating

Press the UP/DOWN button to change the assist level between level 1, 2, and 3. Please note that "OFF" means no motor assistance will be given.

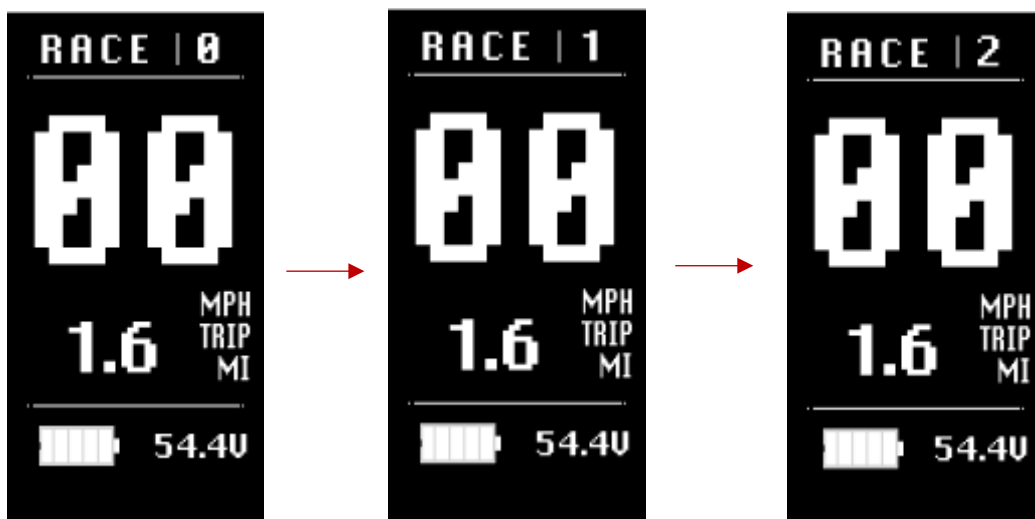



The power output will be distributed evenly across the chosen number of assist levels (or gears) according to the Assist Level Configuration and Speed Limit Assist settings on your Modes & Levels Page on the CYC Ride Control App.

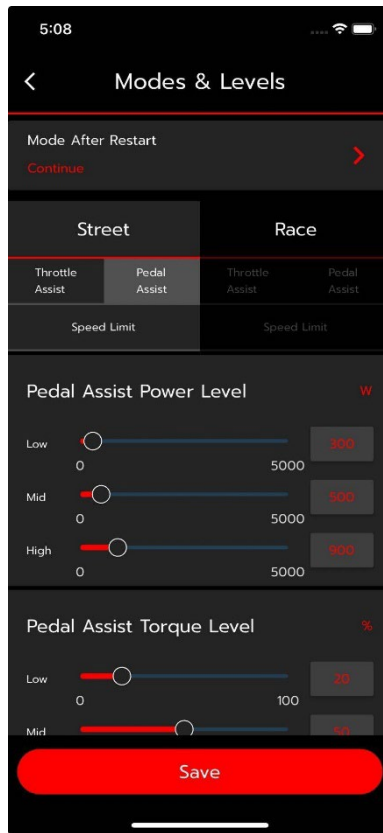

APP ASSIST LEVEL	3 ASSIST LEVELS	5 ASSIST LEVELS	9 ASSIST LEVELS
	0 (Neutral)	0 (Neutral)	0 (Neutral)
<b>1 - 0.3 (30% BY DEFAULT)</b>	1	1	1
			2
		2	3
<b>2 - 0.6 (60% BY DEFAULT)</b>			4
	2	3	5
			6
		4	7
<b>3 - 1 (100% BY DEFAULT)</b>			8
	3	5	9



## Walk Assist

Long press the DOWN button to activate walk assist. Note that it takes 3 seconds to activate & will deactivate immediately when the button is released.

Walk assist can only be activated if you are in assist level 1, 2, or 3.

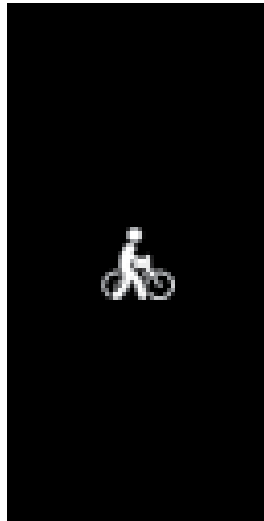

## Settings

Long press the MENU button within 15 seconds of switching on the display to enter the “Settings” page. Note that once the system has been activated for longer than 15 seconds, you will need to restart the motor system to enter the settings menu.

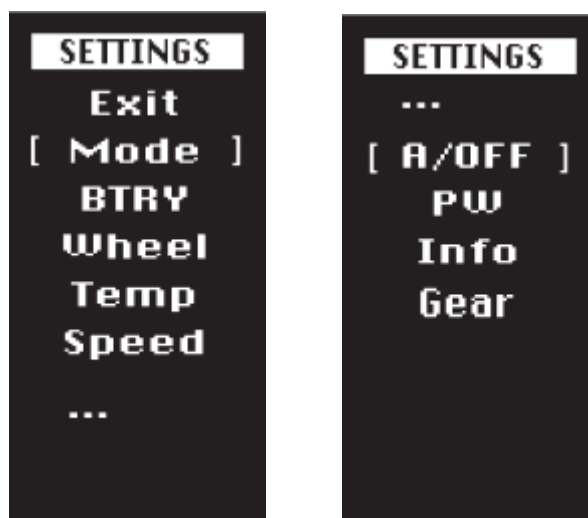





## Clean Trip Data

Wait 15 seconds after starting up the motor system to be able to enter the “Clean Data” menu. Long press the MENU button to clear previous trip data. Please note that the trip data does not automatically clear once you restart the motor system. This is a manual process.



## Error Codes

In certain circumstances, an error code may appear on your display. Contact us for assistance.

Error Code on SW102 Display	Error Code on App
1	Controller Over Voltage
2	Controller Under Voltage
4	Controller Internal Error 1
5	Controller Over Temperature
6	Motor Over Temperature
9	Controller Internal Error 10
10	Controller Internal Error 2
14	Controller Internal Error 3
15	Controller Internal Error 4
16	Controller Internal Error 5
17	Controller Internal Error 6
18	Controller Internal Error 7
23	Controller Internal Error 8
24	Controller Internal Error 9
26	Hall Sensor Error
28	Throttle Error
29	Speed Sensor Error

## Installation

Open the display lock clip, set the display in the left handlebar (standard handlebar size  $\Phi 22.2$ ). Adjust it in place and tighten the screw accordingly.

**Note: Damage caused by excessive torque is not covered by warranty.**

## Pin Layout

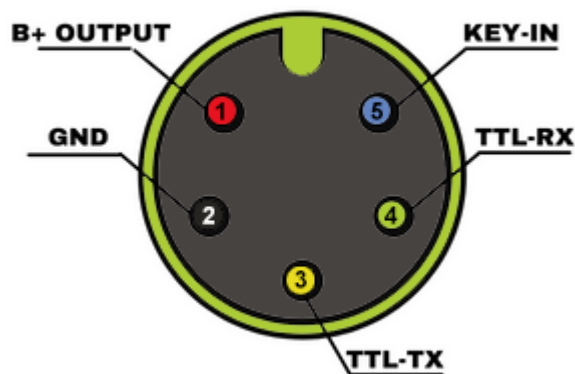

### Male 5-Pin Connector

1. **Red Wire:** Anode (36V to 72V)
2. **Black Wire:** GND
3. **Yellow Wire:** TxD (display -> controller)
4. **Green Wire:** RxD (controller -> display)
5. **Blue wire:** Power cord to the controller

## Certification

CE / IP65 (waterproof) / ROHS

Be sure to contact us if further assistance is needed. Thank you!